

thank you

for choosing our products for your audio needs. We've carefully designed it with our client's best interests in mind, aiming to provide nothing but the finest. Our aspiration is that it matches your expectations.

Your feedback is invaluable to us. Feel free to share your experience with our products & services by leaving a review on our website.



HEY!
VISIT OUR WEBSITE

Feel free to reach out if you have any questions or concerns. We're happy to help!

AF106T *Installation Manual*

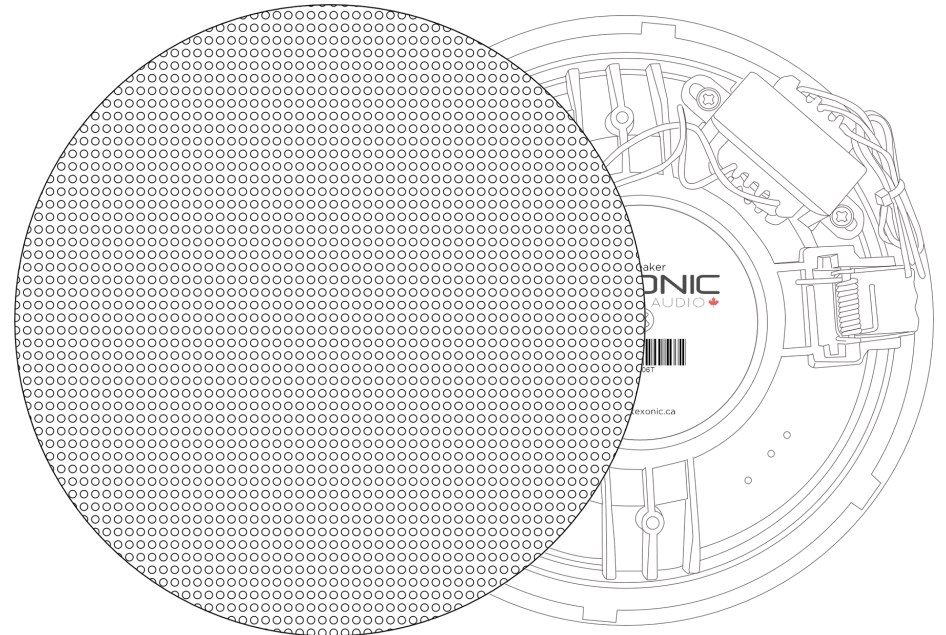

6" In-ceiling Commercial Speaker

TEXONIC
AUDIO 

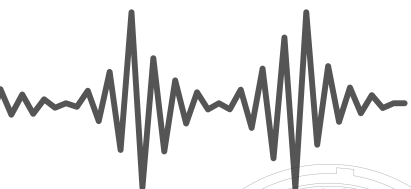

Dimensions

Rear View

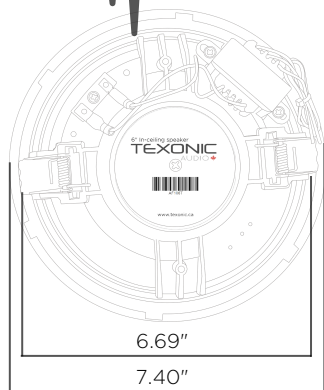

Side View

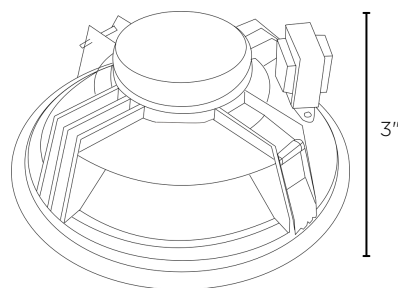

Specifications

***Power Taps BLACK-COM, RED-10W, WHITE-5W

Line Input	100V
Impedance	Red:1KΩ White:2KΩ
SPL(1W/1M)	88 dB
Freq. Response	90-20KHz

Woofers Driver	6"*1
Tweeter Driver	1"*1
Material	ABS enclosure, metal grills
Cutout Size	Φ170mm

Installation

STEP 1

With the cutout template, mark the designated area prior to making the cut.

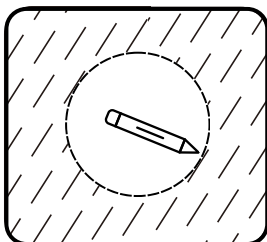

STEP 2

Cut out the area you've marked by using either a hole saw with the drill or a hand-held jigsaw.

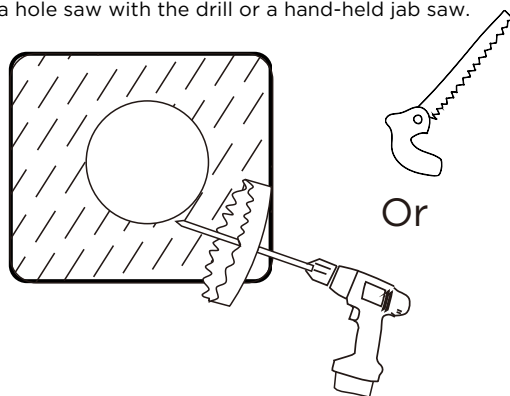

STEP 3

Connect the wires you threaded through the wall to the rear of the speaker.

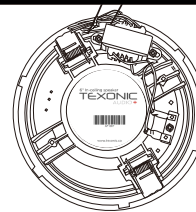
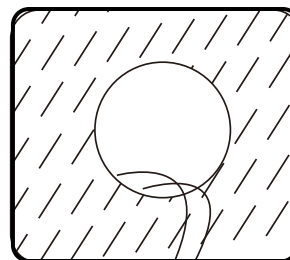

STEP 4

First, pull back the 2 Snap Clamps on the speaker to their open position. Next, push the speaker up through the ceiling opening. As the Clamp Arms make contact with the ceiling, the Snap Clamps will rotate and securely fasten to the ceiling surface.

Once properly inserted, both SnapClamps will be in the snapped-down position, ensuring a secure attachment of the speaker in the ceiling.

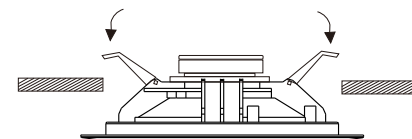
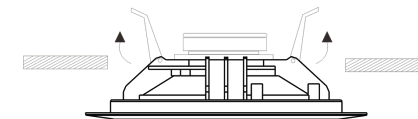

STEP 5

All done. Proceed to connect the remaining equipment and enjoy the music.

